



Version A



Version B



Version C

<b>Case :</b>	32.0(W)x40.5(H)mm
<b>Dial Opening :</b>	Ø28.0mm
<b>Bracelet / Strap :</b>	13.0x12.0mm
<b>Crown :</b>	Ø3.5mm
<b>Water Resistant :</b>	3ATM
<b>Scale :</b>	100%

<b>Model No.:</b>	<b>Case Material:</b>	<b>Movement:</b> VJ21	<b>Marketing:</b> Niki
<b>Brand Name:</b> Carly Rex DENMARK	<b>Design Ref. No.:</b> CS2104049	<b>Designer:</b> Andrew ★	<b>Date:</b> 27/Apr/2021



Version A

Logo size: 5.5mm



Version B



Version C

<b>Case :</b>	24.0(W)x30.0(H)mm
<b>Dial Opening :</b>	Ø20.0mm
<b>Bracelet / Strap :</b>	10.0x10.0mm
<b>Crown :</b>	Ø3.0mm
<b>Water Resistant :</b>	3ATM
<b>Scale :</b>	100%

<b>Model No.:</b>	<b>Case Material:</b>	<b>Movement:</b> 2035	<b>Marketing:</b> Niki
<b>Brand Name:</b> Carly Rex DENMARK	<b>Design Ref. No.:</b> CS2104050	<b>Designer:</b> Andrew	<b>Date:</b> 29/Apr/2021



Version A



Version B



Version C

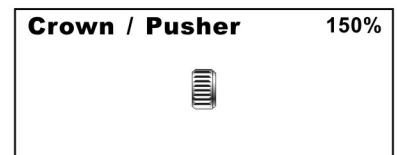
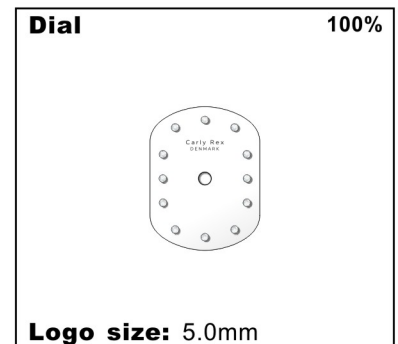

<b>Case :</b>	20.0(W)x31.5(H)mm
<b>Dial Opening :</b>	14.5x19.0mm
<b>Bracelet / Strap :</b>	10.0x10.0mm
<b>Crown :</b>	Ø3.5mm
<b>Water Resistant :</b>	3ATM
<b>Scale :</b>	100%

<b>Model No.:</b>	<b>Case Material:</b> Stainless steel	<b>Movement:</b> Y120E	<b>Marketing:</b> Niki
<b>Brand Name:</b> Carly Rex DENMARK	<b>Design Ref. No.:</b> CS2105012	<b>Designer:</b> Andrew	<b>Date:</b> 07/May/2021



Version A



Version B



Version C

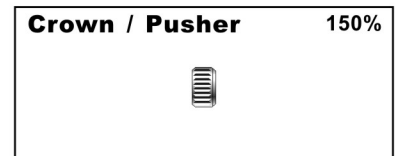

<b>Case :</b>	20.0(W)x31.5(H)mm
<b>Dial Opening :</b>	14.5x19.0mm
<b>Bracelet / Strap :</b>	10.0x10.0mm
<b>Crown :</b>	Ø3.5mm
<b>Water Resistant :</b>	3ATM
<b>Scale :</b>	100%

<b>Model No.:</b>	<b>Case Material:</b> Stainless steel	<b>Movement:</b> Y120E	<b>Marketing:</b> Niki
<b>Brand Name:</b> Carly Rex DENMARK	<b>Design Ref. No.:</b> CS2105012C	<b>Designer:</b> Andrew	<b>Date:</b> 11/May/2021



Version A



Version B



Version C

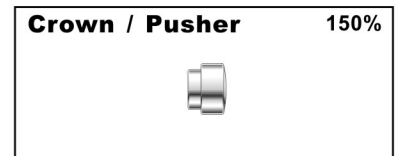
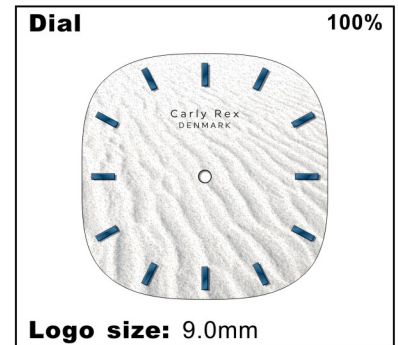
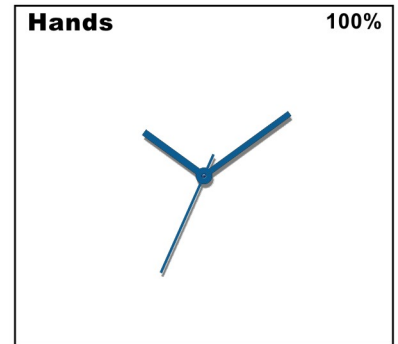

<b>Case :</b>	38.0(W)x44.0(H)mm
<b>Dial Opening :</b>	32.5x32.5mm
<b>Bracelet / Strap :</b>	18.0x16.0mm
<b>Crown :</b>	Ø4.5mm
<b>Water Resistant :</b>	3ATM
<b>Scale :</b>	100%

<b>Model No.:</b>	<b>Case Material:</b> Stainless steel	<b>Movement:</b> 2039	<b>Marketing:</b> Niki
<b>Brand Name:</b> Carly Rex DENMARK	<b>Design Ref. No.:</b> CS2105013	<b>Designer:</b> Andrew	<b>Date:</b> 07/May/2021



Version A

Logo size: 8.0mm



Version B



Version C

<b>Case :</b>	38.0(W)x44.0(H)mm
<b>Dial Opening :</b>	32.5x32.5mm
<b>Bracelet / Strap :</b>	18.0x16.0mm
<b>Crown :</b>	Ø4.5mm
<b>Water Resistant :</b>	3ATM
<b>Scale :</b>	100%

<b>Model No.:</b>	<b>Case Material:</b> Stainless steel	<b>Movement:</b> 2035	<b>Marketing:</b> Rex
<b>Brand Name:</b> Carly Rex DENMARK	<b>Design Ref. No.:</b> CS2106009	<b>Designer:</b> Andrew ★	<b>Date:</b> 07/Jun/2021



C3980ALX-A

C3980ALX-B

C3980ALX-C

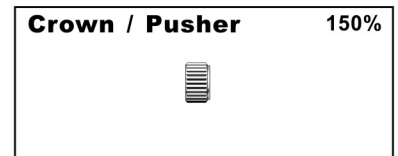
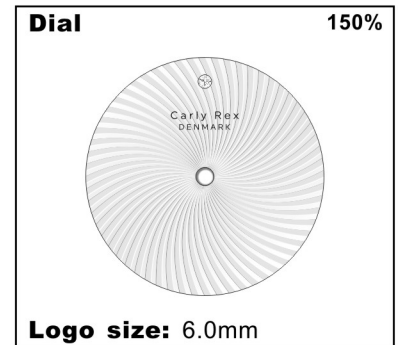
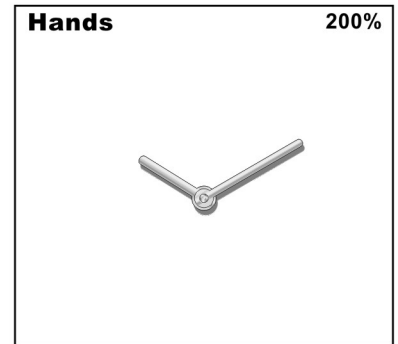

<b>Case :</b>	29.0(W)x33.0(H)mm
<b>Dial Opening :</b>	Ø21.0mm
<b>Bracelet / Strap :</b>	12.0mm
<b>Crown :</b>	Ø3.5mm
<b>Water Resistant :</b>	3ATM
<b>Scale :</b>	100%

<b>Model No.:</b> C3980ALX	<b>Case Material:</b> Alloy	<b>Movement:</b> PC20	<b>Marketing:</b> Paul
<b>Brand Name:</b> Carly Rex DENMARK	<b>Design Ref. No.:</b> CS2106019B	<b>Designer:</b> Andrew	<b>Date:</b> 19/July/2021



<b>Case :</b>	30.0(W)x38.0(H)mm
<b>Dial Opening :</b>	Ø25.7mm
<b>Bracelet / Strap :</b>	10.0x10.0mm
<b>Crown :</b>	Ø3.5mm
<b>Water Resistant :</b>	3ATM
<b>Scale :</b>	100%

<b>Model No.:</b>	<b>Case Material:</b> Stainless steel	<b>Movement:</b> VJ21	<b>Marketing:</b> Kristy
<b>Brand Name:</b> Carly Rex DENMARK	<b>Design Ref. No.:</b> CS2107020	<b>Designer:</b> Tank★	<b>Date:</b> 16/July/2021





Silver white

Sunray

White

Movable

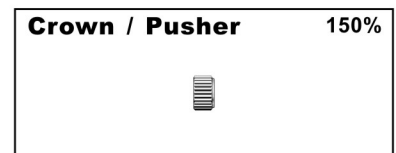

<b>Case :</b>	Ø28.0mm
<b>Dial Opening :</b>	Ø23.5mm
<b>Bracelet / Strap :</b>	32.0x32.0mm
<b>Crown :</b>	Ø3.0mm
<b>Water Resistant :</b>	3ATM
<b>Scale :</b>	100%

Version A

Version B

Version C

<b>Model No.:</b>	<b>Case Material:</b> Alloy	<b>Movement:</b> 2035	<b>Marketing:</b> Kristy
<b>Brand Name:</b> Carly Rex DENMARK	<b>Design Ref. No.:</b> CS2107023B	<b>Designer:</b> Tank	<b>Date:</b> 04/Aug/2021



<b>Case :</b>	34.0(W)x40.0(H)mm
<b>Dial Opening :</b>	Ø29.0mm
<b>Bracelet / Strap :</b>	14.0x14.0mm
<b>Crown :</b>	Ø3.5mm
<b>Water Resistant :</b>	3ATM
<b>Scale :</b>	100%

<b>Model No.:</b>	<b>Case Material:</b> Stainless steel	<b>Movement:</b> VJ21	<b>Marketing:</b> Kristy
<b>Brand Name:</b> Carly Rex DENMARK	<b>Design Ref. No.:</b> CS2107029A	<b>Designer:</b> Andrew ★	<b>Date:</b> 29/July/2021



C3015SLX-A

C3015SLX-B

C3015SLX-C

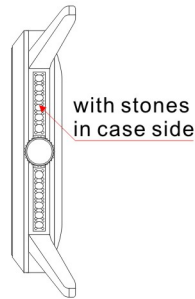

Side View

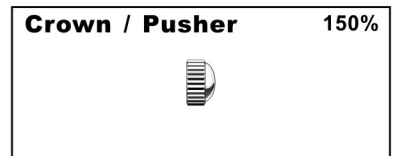
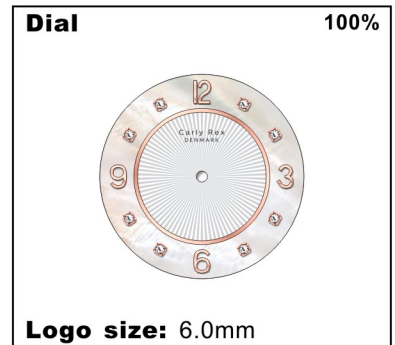

<b>Case :</b>	32.0(W)x38.5(H)mm
<b>Dial Opening :</b>	Ø27.0mm
<b>Bracelet / Strap :</b>	18.0x14.0mm
<b>Crown :</b>	Ø4.0mm
<b>Water Resistant :</b>	
<b>Scale :</b>	100%

<b>Model No.:</b> C3015SLX	<b>Case Material:</b> Stainless steel	<b>Movement:</b> Y121	<b>Marketing:</b> Niki
<b>Brand Name:</b> Carly Rex DENMARK	<b>Design Ref. No.:</b> CS2107030A	<b>Designer:</b> Tank	<b>Date:</b> 02/Aug/2021