

Case :	34.0(W)x36.2(H)mm
Dial Opening :	28.0(W)x30.2(H)mm
Bracelet / Strap :	16.0x16.0mm
Crown :	Ø4.0mm
Water Resistant :	3ATM
Scale :	100%

Model No.:	Case Material: Stainless steel	Movement: VD78	Marketing: Paul
Brand Name: Carly Rex DENMARK	Design Ref. No.: CS2305029A	Designer: Tank	Date: 02/Jun/2023



Case :	32.0(W)x38.5(H)mm
Dial Opening :	Ø27.5mm
Bracelet / Strap :	16.0x14.0mm
Crown :	Ø4.5mm
Water Resistant :	3ATM
Scale :	100%

Model No.:	Case Material: Alloy	Movement: 2035	Marketing: Paul
Brand Name: Carly Rex DENMARK	Design Ref. No.: CS2305133A	Designer: Andrew ★	Date: 30/May/2023



Version A

Version B

Version C

Model No.:	Case Material: Alloy	Movement: PC20S	Marketing: Paul
Brand Name: Carly Rex DENMARK	Design Ref. No.: CS2305134	Designer: Andrew ★	Date: 25/May/2023



Version A



Version B



Version C

Case :	36.0(W)x42.0(H)mm
Dial Opening :	Ø28.0mm
Bracelet / Strap :	18.0x16.0mm
Crown :	Ø4.5mm
Water Resistant :	3ATM
Scale :	100%

Model No.:	Case Material: Stainless steel	Movement: PC21	Marketing: Ho
Brand Name: Carly Rex DENMARK	Design Ref. No.: CS2306026	Designer: Andrew ★	Date: 07/Jun/2023



Version A

Ø1.5mmX40PCS



Version B



Version C

Logo size: 6.0mm

Case :	29.5(W)x42.5(H)mm
Dial Opening :	21.5X15.5mm
Bracelet / Strap :	19.0x17.0mm
Crown :	Ø4.0mm
Water Resistant :	3ATM
Scale :	100%

Model No.:	Case Material: Stainless steel	Movement: 2035	Marketing: Ho
Brand Name: Carly Rex DENMARK	Design Ref. No.: CS2306028	Designer: Andrew ★	Date: 07/Jun/2023



Version A

Version B

Version C

Case :	28.0(W)x34.6(H)mm
Dial Opening :	Ø23.0mm
Bracelet / Strap :	14.0x14.0mm
Crown :	Ø3.5mm
Water Resistant :	3ATM
Scale :	100%

Model No.:	Case Material: Titanium	Movement: Miyota 2035	Marketing:
Brand Name: Carly Rex DENMARK	Design Ref. No.: 2397T	Designer:	Date: 06/06/2026

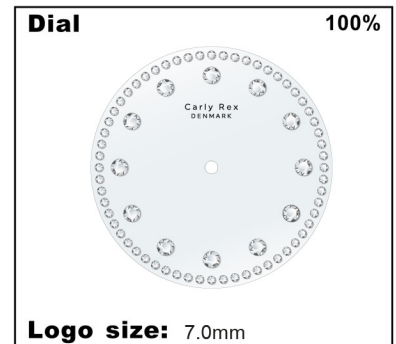

Case :	Ø 36.0mm
Dial Opening :	Ø 32.0mm
Bracelet / Strap :	16.0 x 14.0mm
Crown :	Ø 4.0mm
Water Resistant :	3 ATM
Scale :	100%

Model No.:	Case Material: Alloy	Movement: Seiko PC21S	Marketing: Niki
Brand Name: Carly Rex DENMARK	Design Ref. No.: M-1149-01-R2(GCA-7020)	Designer: Global Creation	Date: 06/June/2023



Case :	Ø 36.0mm
Dial Opening :	Ø 29.5mm
Bracelet / Strap :	18.0 x 16.0mm
Crown :	Ø 4.0mm
Water Resistant :	3 ATM
Scale :	100%

Model No.:	Case Material: Alloy	Movement: Seiko PC21S	Marketing: Niki
Brand Name: Carly Rex DENMARK	Design Ref. No.: M-1155-02-R1(GCA-7024)	Designer: Global Creation	Date: 06/June/2023

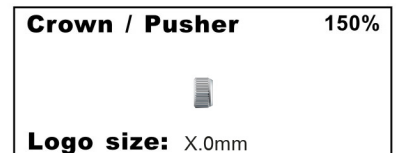

Case :	34.0(W)x 46.0(H)mm
Dial Opening :	28.0 x 33.0mm
Bracelet / Strap :	18.0 x 18.0mm
Crown :	Ø 4.0mm
Water Resistant :	3 ATM
Scale :	100%

Version A

Version B

Version C

Model No.:	Case Material: Alloy	Movement: Seiko PC21S	Marketing: Niki
Brand Name: Carly Rex DENMARK	Design Ref. No.: M-1154-01-R2(GCA7072)	Designer: Global Creation	Date: 06/June/2023



A

B

C

Logo size: 8.0mm

Case :	34.0(W)x41.0(H)mm
Dial Opening :	Ø27.0mm
Bracelet / Strap :	16.0x16.0mm
Crown :	Ø4.0mm
Water Resistant :	3ATM
Scale :	100%

Model No.:	Case Material: Alloy	Movement: Y121	Marketing: Andy
Brand Name: Carly Rex DENMARK	Design Ref. No.: CS2305096B	Designer: Andrew ★	Date: 31/May/2023

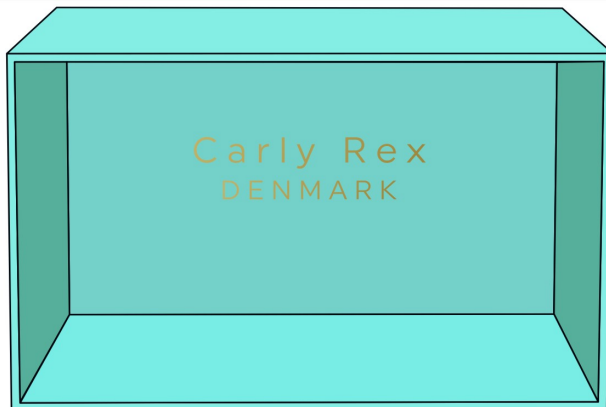

A



B

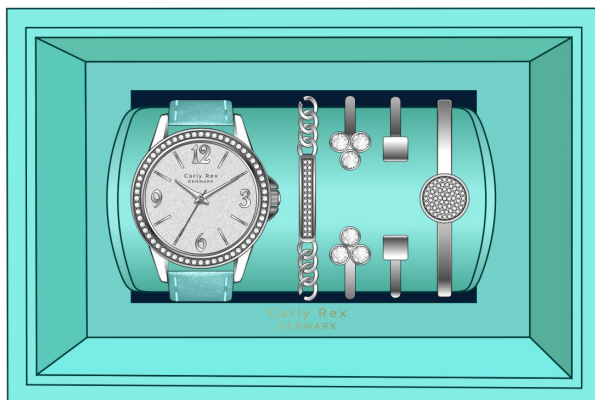

C

Box size: 150(L)X100(W)X82(H)mm

Pillow size: 109(L)X60(D)

Model No.:	Case Material:	Movement:	Marketing: Andy
Brand Name: Carly Rex DENMARK	Design Ref. No.: CS2305131A	Designer: Tank ★	Date: 29/May/2023



Version A



Version B

Case :	32.0(W)x41.0(H)mm
Dial Opening :	Ø27.0mm
Bracelet / Strap :	14.0x14.0mm
Crown :	Ø3.5mm
Water Resistant :	3ATM
Scale :	100%

Model No.:	Case Material: Alloy	Movement: Y121	Marketing: Andy
Brand Name: Carly Rex DENMARK	Design Ref. No.: CS2305101A	Designer: Andrew ★	Date: 24/May/2023

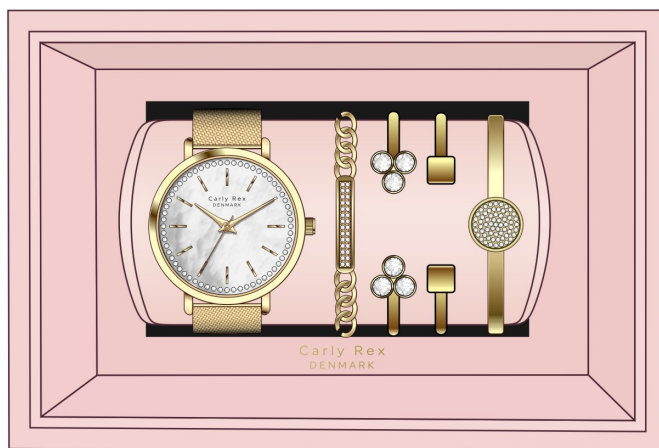

A

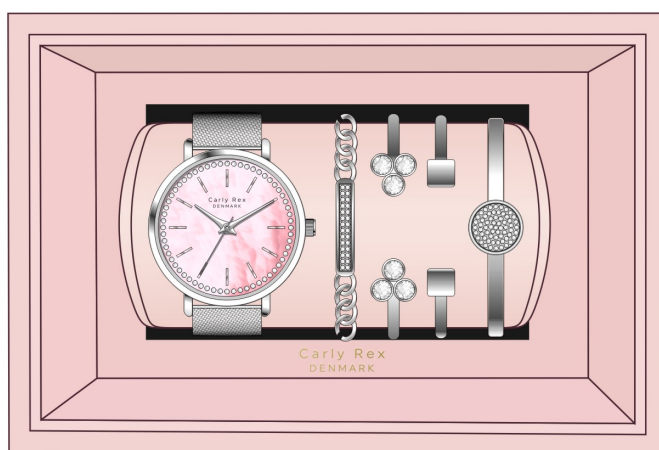

B

Box size:150(L)X100(W)X82(H)mm
Pillow size:109(L)X60(D)

Model No.:	Case Material:	Movement:	Marketing: Andy
Brand Name: Carly Rex DENMARK	Design Ref. No.: CS2305132A	Designer: Tank ★	Date: 29/May/2023



Version A

Version B

Version C

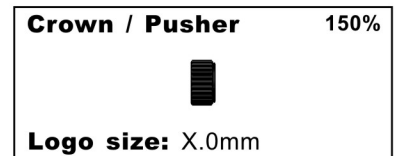
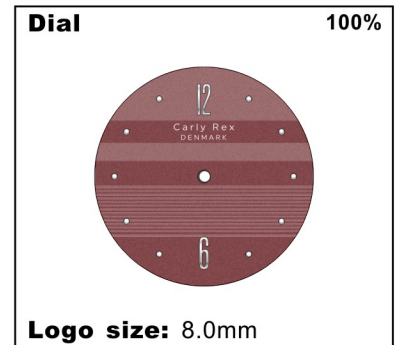

Case :	32.0(W)x39.0(H)mm
Dial Opening :	Ø29.0mm
Bracelet / Strap :	14.0x14.0mm
Crown :	Ø4.0mm
Water Resistant :	3ATM
Scale :	100%

Model No.:	Case Material: Alloy	Movement: 2035	Marketing: Niki
Brand Name: Carly Rex DENMARK	Design Ref. No.: CS2305126	Designer: Tank	Date: 24/May/2023



■ PT:7518C

Version A



■ PT:4735C

Version B



Logo size: 6.0mm

Version C

Case :	30.5(W)x36.0(H)mm
Dial Opening :	22.5x25.0mm
Bracelet / Strap :	16.0x14.0mm
Crown :	Ø4.0mm
Water Resistant :	3ATM
Scale :	100%

Model No.:	Case Material: Alloy	Movement: 2035	Marketing: Ho
Brand Name: Carly Rex DENMARK	Design Ref. No.: CS2305136	Designer: Andrew ★	Date: 25/May/2023



Version A



Version B



Version C

Case :	34.0(W)x39.0(H)mm
Dial Opening :	Ø28.5mm
Bracelet / Strap :	14.0x14.0mm
Crown :	Ø4.0mm
Water Resistant :	3ATM
Scale :	100%

Model No.:	Case Material: Alloy	Movement: 2035	Marketing: Ho
Brand Name: Carly Rex DENMARK	Design Ref. No.: CS2305137	Designer: Andrew ★	Date: 25/May/2023



Version A



Version B



Version C

Case :	20.0(W)x26.5(H)mm
Dial Opening :	14.8x21.6mm
Bracelet / Strap :	12.0x12.0mm
Crown :	Ø3.5mm
Water Resistant :	3ATM
Scale :	100%

Model No.:	Case Material: Alloy	Movement: 2035	Marketing: Ho
Brand Name: Carly Rex DENMARK	Design Ref. No.: CS2305139	Designer: Andrew ★	Date: 25/May/2023



Version A



Version B

■ PN:7483C



Version C

Case :	29.0(W)x34.5(H)mm
Dial Opening :	Ø21.0mm
Bracelet / Strap :	14.0x14.0mm
Crown :	Ø4.0mm
Water Resistant :	3ATM
Scale :	100%

Model No.:	Case Material: Alloy	Movement: 2035	Marketing: Ho
Brand Name: Carly Rex DENMARK	Design Ref. No.: CS2305140	Designer: Andrew ★	Date: 25/May/2023



Version A



Version B

PT:629C



Version C

Logo size: 6.5mm

Case :	34.0(W)x41.0(H)mm
Dial Opening :	Ø29.0mm
Bracelet / Strap :	12.0x10.0mm
Crown :	Ø4.5mm
Water Resistant :	3ATM
Scale :	100%

Model No.:	Case Material: Alloy	Movement: 2035	Marketing: Ho
Brand Name: Carly Rex DENMARK	Design Ref. No.: CS2305141	Designer: Andrew ★	Date: 25/May/2023



Version A

Version B

Version C

Case :	24.0(W)x33.5(H)mm
Dial Opening :	17.0x22.0mm
Bracelet / Strap :	10.0x10.0mm
Crown :	Ø3.0mm
Water Resistant :	3ATM
Scale :	100%

Model No.:	Case Material: Alloy	Movement: 2035	Marketing: Ho
Brand Name: Carly Rex DENMARK	Design Ref. No.: CS2305142	Designer: Andrew ★	Date: 25/May/2023



Version A

Version B

Version C

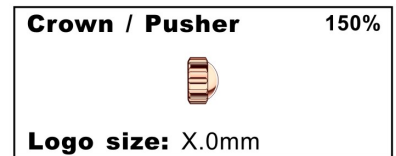
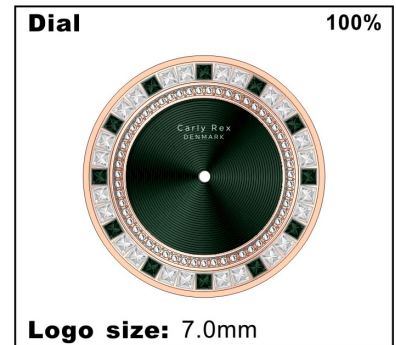
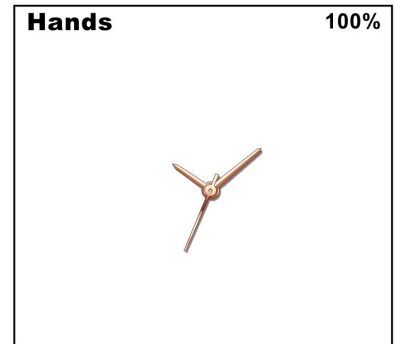

Case :	36.0(W)x42.0(H)mm
Dial Opening :	Ø32.0mm
Bracelet / Strap :	16.0x14.0mm
Crown :	Ø4.0mm
Water Resistant :	3ATM
Scale :	100%

Model No.:	Case Material: Alloy	Movement: 2035	Marketing: Niki
Brand Name: Carly Rex DENMARK	Design Ref. No.: CS2305155	Designer: Tank	Date: 26/May/2023



Version A

Version B

Version C

Case :	34.0(W)x40.0(H)mm
Dial Opening :	Ø28.5mm
Bracelet / Strap :	16.0x14.0mm
Crown :	Ø4.5mm
Water Resistant :	3ATM
Scale :	100%

Model No.:	Case Material: Stainless steel	Movement: 2035	Marketing: Andy
Brand Name: Carly Rex DENMARK	Design Ref. No.: CS2305023B	Designer: Andrew ★	Date: 22/May/2023



Version A

Version B

Version C

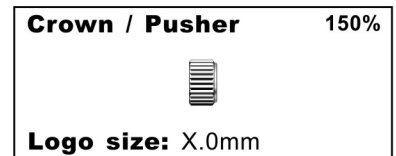
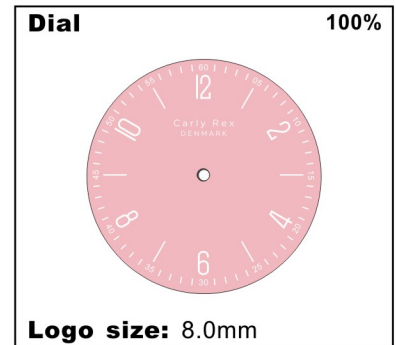
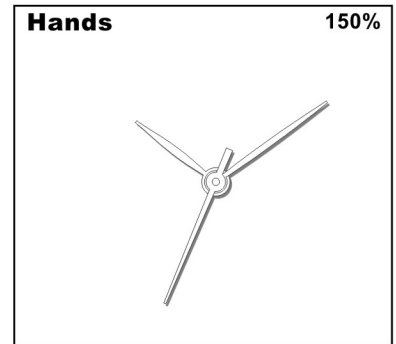

Case :	35.0(W)x41.0(H)mm
Dial Opening :	Ø31.0mm
Bracelet / Strap :	16.0x16.0mm
Crown :	Ø4.0mm
Water Resistant :	3ATM
Scale :	100%

Model No.:	Case Material: Alloy	Movement: PC21J	Marketing: Paul
Brand Name: Carly Rex DENMARK	Design Ref. No.: CS2305035A	Designer: Tank	Date: 25/May/2023



Version A

Version B

Version C

Case :	Ø32.0mm
Dial Opening :	Ø28.0mm
Bracelet / Strap :	12.0x12.0mm
Crown :	Ø3.5mm
Water Resistant :	3ATM
Scale :	100%

Model No.:	Case Material: Alloy	Movement: 2035	Marketing: Andy
Brand Name: Carly Rex DENMARK	Design Ref. No.: CS2305048A	Designer: Andrew ★	Date: 19/May/2023



Case :	32.0(W)x37.0(H)mm
Dial Opening :	Ø22.0mm
Bracelet / Strap :	16.0x14.0mm
Crown :	Ø4.0mm
Water Resistant :	5ATM
Scale :	100%

Model No.:	Case Material: Stainless steel	Movement: 2115	Marketing: Ho
Brand Name: Carly Rex DENMARK	Design Ref. No.: CS2305064A	Designer: Andrew ★	Date: 24/May/2023



Version A



Version B



Version C

Logo size: 7.0mm

Case :	36.0(W)x42.5(H)mm
Dial Opening :	Ø30.5mm
Bracelet / Strap :	18.0x16.0mm
Crown :	Ø4.0mm
Water Resistant :	3ATM
Scale :	100%

Model No.:	Case Material: Alloy	Movement: PC21S	Marketing: Ho
Brand Name: Carly Rex DENMARK	Design Ref. No.: CS2305065	Designer: Andrew ★	Date: 16/May/2023



Version A



Version B



Version C

Logo size: 6.0mm

Case :	33.5(W)x39.0(H)mm
Dial Opening :	Ø24.5mm
Bracelet / Strap :	16.0x14.0mm
Crown :	Ø4.0mm
Water Resistant :	3ATM
Scale :	100%

Model No.:	Case Material: Alloy	Movement: PC21S	Marketing: Ho
Brand Name: Carly Rex DENMARK	Design Ref. No.: CS2305066	Designer: Andrew ★	Date: 16/May/2023

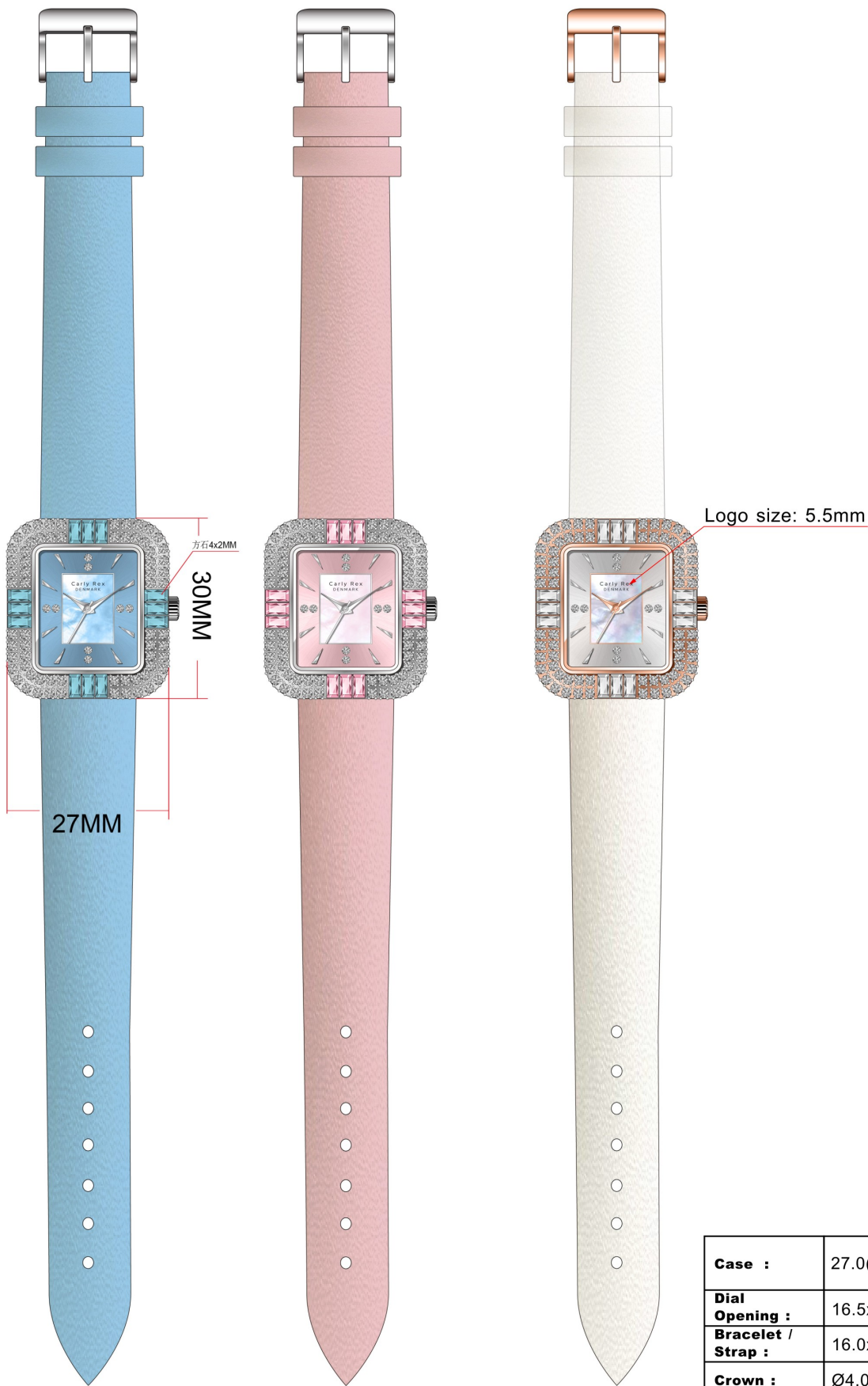

Version A

Version B

Version C

Case :	27.0(W)x30.0(H)mm
Dial Opening :	16.5x19.5mm
Bracelet / Strap :	16.0x14.0mm
Crown :	Ø4.0mm
Water Resistant :	3ATM
Scale :	100%

Model No.:	Case Material: Alloy	Movement: PC21S	Marketing: Ho
Brand Name: Carly Rex DENMARK	Design Ref. No.: CS2305067	Designer: Andrew ★	Date: 16/May/2023



Version A

Version B

Version C

Case :	36.0(W)x44.0(H)mm
Dial Opening :	Ø29.5mm
Bracelet / Strap :	17.0x16.0mm
Crown :	Ø4.5mm
Water Resistant :	3ATM
Scale :	100%

Model No.:	Case Material: Alloy	Movement: PC21S	Marketing: Ho
Brand Name: Carly Rex DENMARK	Design Ref. No.: CS2305068	Designer: Andrew ★	Date: 16/May/2023



Case :	34.0(W)x45.0(H)mm
Dial Opening :	Ø27.5mm
Bracelet / Strap :	16.0x14.0mm
Crown :	Ø4.0mm
Water Resistant :	3ATM
Scale :	100%

Model No.:	Case Material: Alloy	Movement: 2035	Marketing: Kristy
Brand Name: Carly Rex DENMARK	Design Ref. No.: CS2305084A	Designer: Andrew ★	Date: 25/May/2023



Version A

Version B

Version C

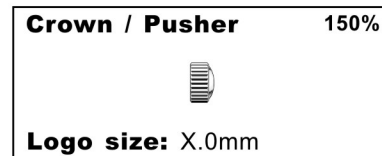
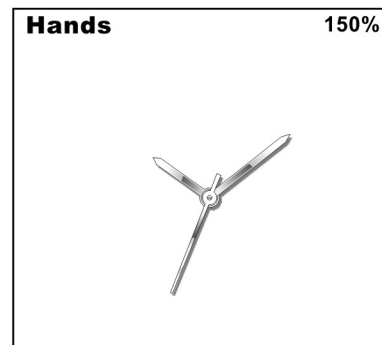

Case :	26.0(W)x33.0(H)mm
Dial Opening :	20.5(W)x19.5(H)mm
Bracelet / Strap :	12.0x10.0mm
Crown :	Ø3.5mm
Water Resistant :	3ATM
Scale :	100%

Model No.:	Case Material: Alloy	Movement: 2035	Marketing: Paul
Brand Name: Carly Rex DENMARK	Design Ref. No.: CS2305114A	Designer: Tank	Date: 25/May/2023



Version A

Version B

Version C

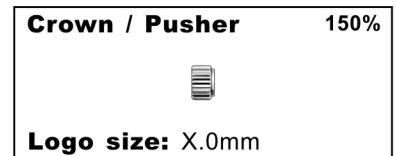
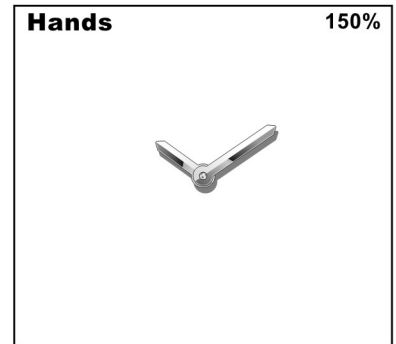

Case :	23.0(W)x33.0(H)mm
Dial Opening :	19.0x29.0mm
Bracelet / Strap :	12.0x10.0mm
Crown :	Ø3.0mm
Water Resistant :	3ATM
Scale :	100%

Model No.:	Case Material: Stainless steel	Movement: 2025	Marketing: Paul
Brand Name: Carly Rex DENMARK	Design Ref. No.: CS2305115A	Designer: Tank	Date: 25/May/2023



C3122ACX-A



C3122ACX-B



C3122ACX-C

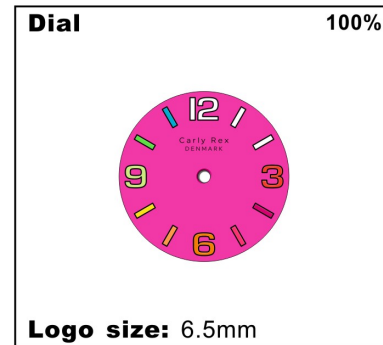
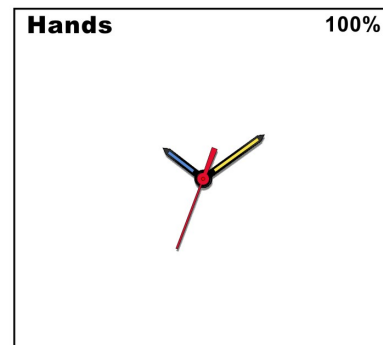

Case :	Existing Case 27.0(W)x33.0(H)mm
Dial Opening :	Ø22.5mm
Bracelet / Strap :	14.0x14.0mm
Crown :	Ø4.0mm
Water Resistant :	3ATM
Scale :	100%

Model No.: C3122ACX	Case Material: Alloy	Movement: 2035	Marketing: Paul
Brand Name: Carly Rex DENMARK	Design Ref. No.: CS2305116	Designer: Andrew/Tank	Date: 22/May/2023



Version A



Version B



Version C

Logo size: 7.0mm

Case :	38.0(W)x42.0(H)mm
Dial Opening :	26.0x26.0mm
Bracelet / Strap :	18.0x16.0mm
Crown :	Ø5.0mm
Water Resistant :	5ATM
Scale :	100%

Model No.:	Case Material: Stainless steel	Movement: 2115	Marketing: Ho
Brand Name: Carly Rex DENMARK	Design Ref. No.: CS2305121	Designer: Andrew ★	Date: 22/May/2023



Case :	30.0(W)x36.0(H)mm
Dial Opening :	Ø26.0mm
Bracelet / Strap :	16.0x14.0mm
Crown :	Ø3.5mm
Water Resistant :	3ATM
Scale :	100%

Model No.:	Case Material: Alloy	Movement: PC21S	Marketing: Ho
Brand Name: Carly Rex DENMARK	Design Ref. No.: CS2305123	Designer: Andrew ★	Date: 22/May/2023



Version A

Version B

Version C

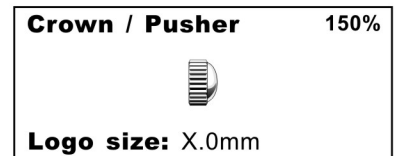

Case :	25.5(W)x32.0(H)mm
Dial Opening :	Ø19.0mm
Bracelet / Strap :	10.0x10.0mm
Crown :	Ø4.0mm
Water Resistant :	3ATM
Scale :	100%

Model No.:	Case Material: Alloy	Movement: PC21J	Marketing: Paul
Brand Name: Carly Rex DENMARK	Design Ref. No.: CS2305125A	Designer: Tank	Date: 25/May/2023

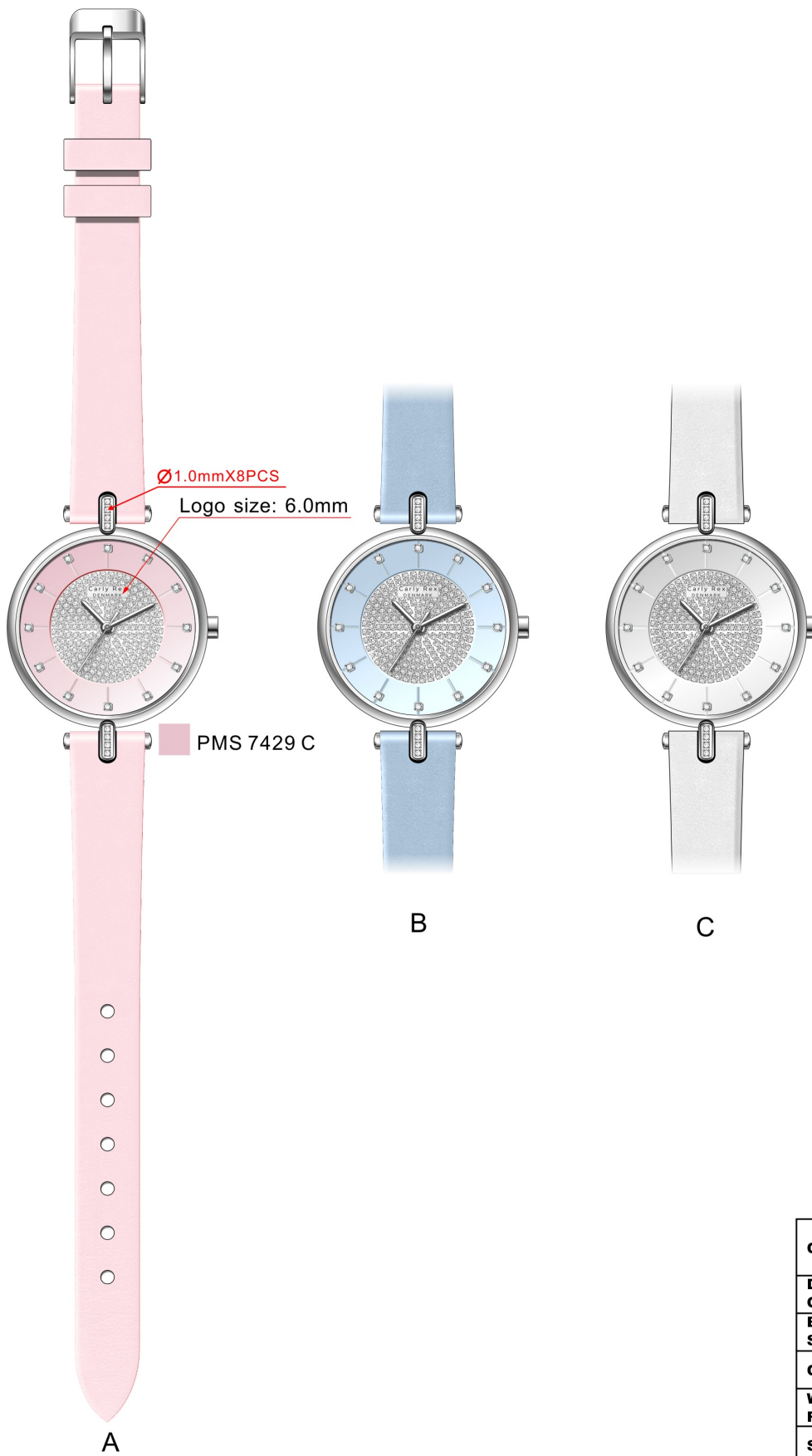

Case :	32.0(W)x43.0(H)mm
Dial Opening :	Ø28.0mm
Bracelet / Strap :	12.0x10.0mm
Crown :	Ø3.5mm
Water Resistant :	3ATM
Scale :	100%

Model No.:	Case Material: Stainless steel	Movement: 2035	Marketing: Peggy
Brand Name: Carly Rex DENMARK	Design Ref. No.: CS2305128A	Designer: Andrew ★	Date: 25/May/2023



Version A



Version B



Version C

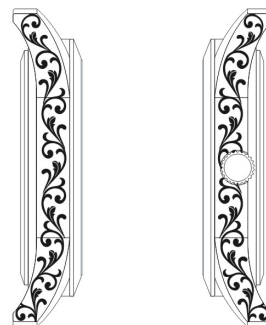

Side View(9H) Side View(3H)



Case :	34.0(W)x42.0(H)mm
Dial Opening :	Ø28.0mm
Bracelet / Strap :	18.0x16.0mm
Crown :	Ø4.5mm
Water Resistant :	5ATM
Scale :	100%

Model No.:	Case Material: Stainless steel	Movement: 2035	Marketing: Paul
Brand Name: Carly Rex DENMARK	Design Ref. No.: CS2305129	Designer: Andrew	Date: 25/May/2023



Version A

Version B

Version C

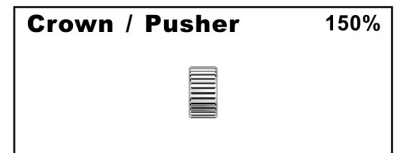
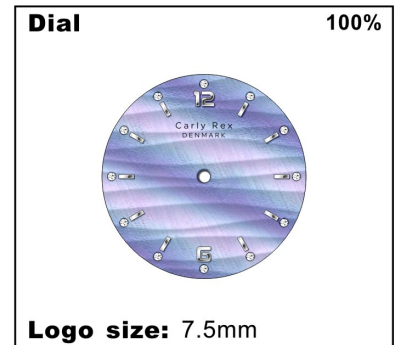
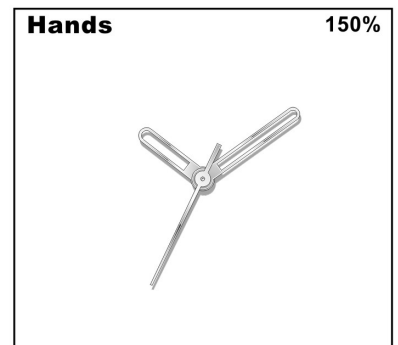

Case :	33.0(W)x42.0(H)mm
Dial Opening :	Ø27.0mm
Bracelet / Strap :	16.0x14.0mm
Crown :	Ø4.5mm
Water Resistant :	3ATM
Scale :	100%

Model No.:	Case Material: Plastic	Movement: 2035	Marketing: Paul
Brand Name: Carly Rex DENMARK	Design Ref. No.: CS2305130	Designer: Andrew	Date: 25/May/2023



Version:A

■ Cool grey 10C



Version:B

■ Cool grey 10C



Version:C

■ 8743C

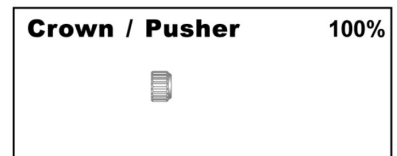
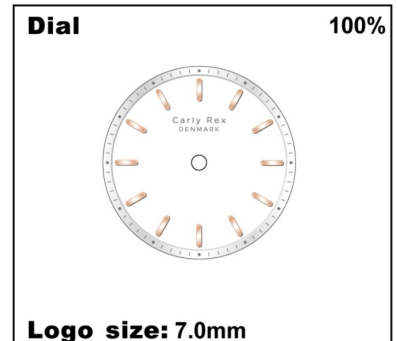
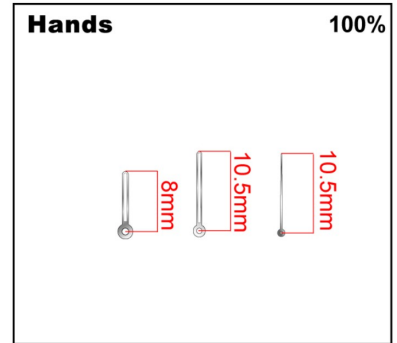

Case :	30.5(W)x38.0(H)mm
Dial Opening :	Ø31.25mm
Bracelet / Strap :	16mm
Crown :	Ø4.0mm
Water Resistant :	3ATM
Scale :	100%

Model No.:	Case Material: Stainless steel	Movement: 2035	Marketing: Paul
Brand Name: Carly Rex DENMARK	Design Ref. No.: CS2305031A	Designer: Andrew ★	Date: 17/May/2023



Case :	32.0(W)x38.5(H)mm
Dial Opening :	Ø27.0mm
Bracelet / Strap :	16.0x14.0mm
Crown :	Ø4.0mm
Water Resistant :	3ATM
Scale :	100%

Model No.:	Case Material: Stainless steel	Movement: 2035	Marketing: Peggy
Brand Name: Carly Rex DENMARK	Design Ref. No.: CS2305009	Designer: Andrew ★	Date: 04/May/2023



Case :	33.0(W)x38.5(H)mm
Dial Opening :	Ø28.5mm
Bracelet / Strap :	16.0x14.0mm
Crown :	Ø4.0mm
Water Resistant :	3ATM
Scale :	100%

Model No.:	Case Material: Stainless steel	Movement: VX3J	Marketing: Peggy
Brand Name: Carly Rex DENMARK	Design Ref. No.: CS2305012	Designer: Andrew ★	Date: 04/May/2023



Version A



Version B



Version C

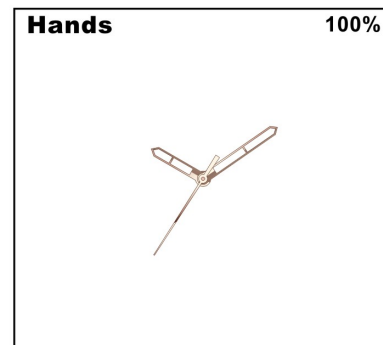

Case :	39.0(W)x44.0(H)mm
Dial Opening :	Ø29.0mm
Bracelet / Strap :	20.0x18.0mm
Crown :	Ø5.5mm
Water Resistant :	5ATM
Scale :	100%

Model No.:	Case Material: Stainless steel	Movement: VX9J	Marketing: Peggy
Brand Name: Carly Rex DENMARK	Design Ref. No.: CS2305043	Designer: Andrew	Date: 12/May/2023



Version A



Version B



Version C

Logo size:7.0mm

Case :	33.0(W)x34.5(H)mm
Dial Opening :	Ø26.0mm
Bracelet / Strap :	18.0x16.0mm
Crown :	Ø3.0mm
Water Resistant :	3ATM
Scale :	100%

Model No.:	Case Material: Stainless steel	Movement: VJ20	Marketing: Ho
Brand Name: Carly Rex DENMARK	Design Ref. No.: CS2302104A	Designer: Tank ★	Date: 22/Feb/2023

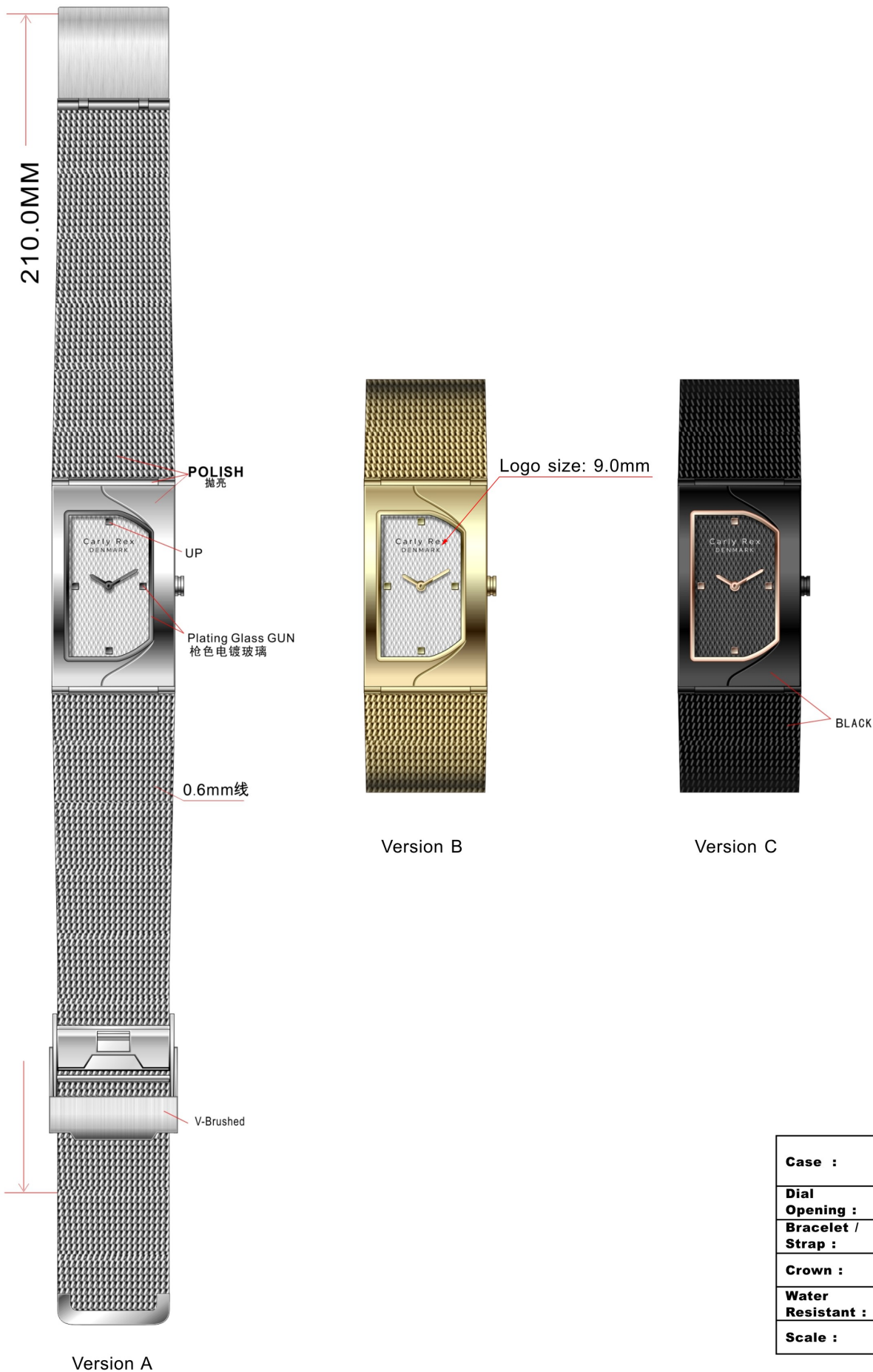

Case :	22.0(W)x38.5(H)mm
Dial Opening :	14.3x25.3mm
Bracelet / Strap :	22.0x20.0mm
Crown :	Ø3.5mm
Water Resistant :	3ATM
Scale :	100%

Model No.:	Case Material: Stainless steel	Movement: 2025	Marketing: Kristy
Brand Name: Carly Rex DENMARK	Design Ref. No.: CS2302109	Designer: Andrew ★	Date: 21/Feb/2023



Version A



Version B



Version C

Case :	30.0(W)x39.0(H)mm
Dial Opening :	24.0x24.0mm
Bracelet / Strap :	19.0x16.0mm
Crown :	Ø4.5mm
Water Resistant :	3ATM
Scale :	100%

Model No.:	Case Material: Stainless steel	Movement: 2035	Marketing: Paul
Brand Name: Carly Rex DENMARK	Design Ref. No.: CS2302110	Designer: Andrew	Date: 21/Feb/2023



C2941SLX-A

C2941SLX-B

C2941SLX-C

C2941SLX-D

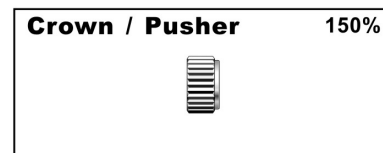
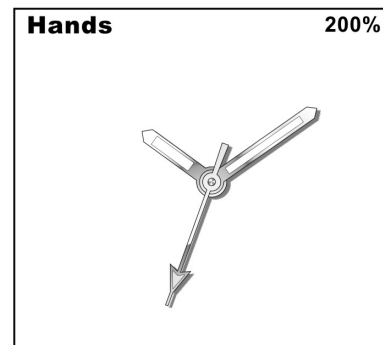

Case :	Existing Case 31.0(W)x35.5(H)mm
Dial Opening :	Ø20.5mm
Bracelet / Strap :	16.0x16.0mm
Crown :	Ø5.0mm
Water Resistant :	10ATM
Scale :	100%

Model No.: C2941SLX	Case Material: Stainless steel	Movement: 2015	Marketing: Ho
Brand Name: Carly Rex DENMARK	Design Ref. No.: CS2302005B	Designer: Tank	Date: 16/Feb/2023

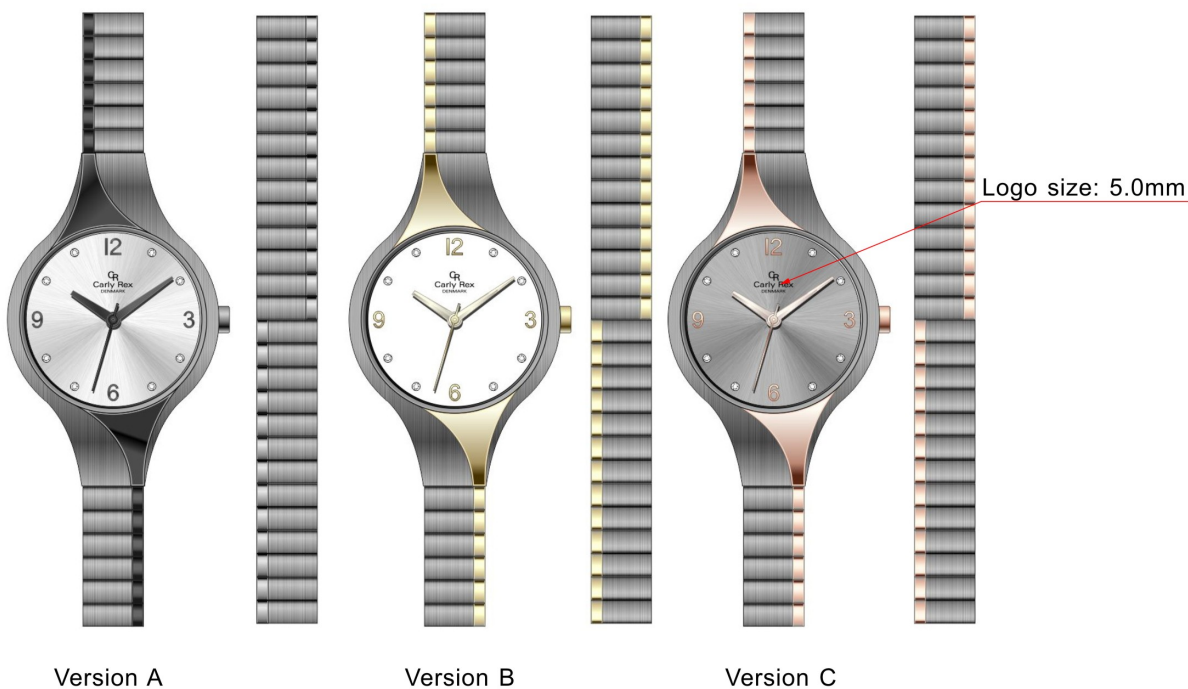

Version A

Version B

Version C

Case :	28.0(W)x44.0(H)mm
Dial Opening :	Ø23.0mm
Bracelet / Strap :	8.0x8.0mm
Crown :	Ø3.5mm
Water Resistant :	3ATM
Scale :	100%

Model No.:	Case Material: Titanium	Movement: VJ21	Marketing: Ho
Brand Name: Carly Rex DENMARK	Design Ref. No.: Cs2302077	Designer: Andrew ★	Date: 15/Feb/2023



C3929ALX-A

C3929ALX-B

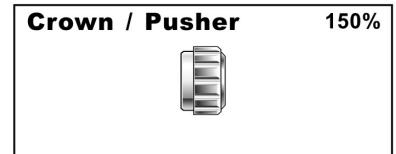

Case :	45.0(W)x49.8(H)mm
Dial Opening :	Ø32.5mm
Bracelet / Strap :	20.0x18.0mm
Crown :	Ø6.0mm
Water Resistant :	5ATM
Scale :	100%

Model No.: C3929ALX	Case Material: Alloy	Movement: 2035	Marketing: Ho
Brand Name: Carly Rex DENMARK	Design Ref. No.: CS2302004B	Designer: Tank	Date: 08/Feb/2023



C3929ALX-C



C3929ALX-D

Model No.: C3929ALX	Case Material: Alloy	Movement: 2035	Marketing: Ho
Brand Name: Carly Rex DENMARK	Design Ref. No.: CS2302004B	Designer: Tank	Date: 08/Feb/2023



Version A



Version B



Version C



Version D



Version E

Logo size: 8.0mm

Case :	40.0(W)mm
Dial Opening :	
Bracelet / Strap :	
Crown :	
Water Resistant :	3ATM
Scale :	100%

Model No.:	Case Material: Plastic	Movement:	Marketing: Niki
Brand Name: Carly Rex DENMARK	Design Ref. No.: CS2302051B	Designer: Andrew ★	Date: 10/Feb/2023

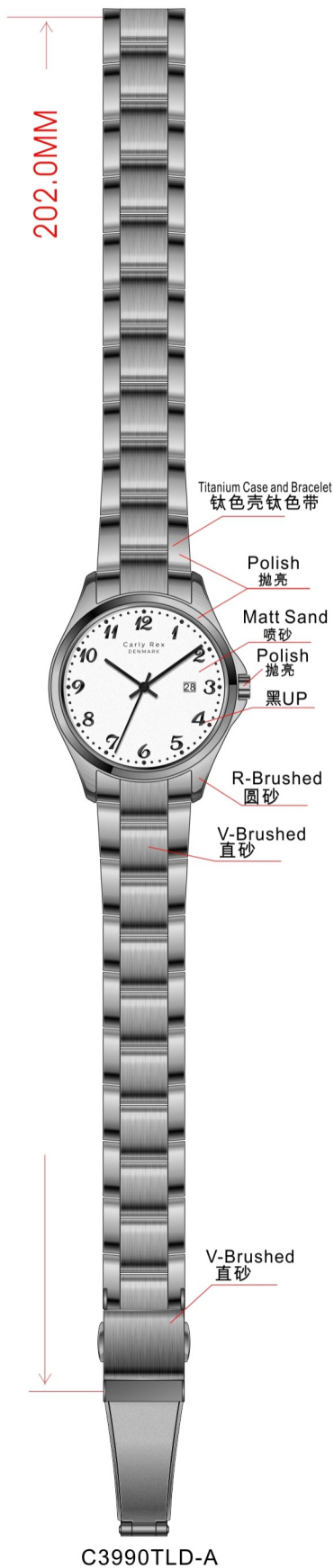

Case :	28.0(W)x34.0(H)mm
Dial Opening :	Ø23.75mm
Bracelet / Strap :	14.0x12.0mm
Crown :	Ø3.5mm
Water Resistant :	5ATM
Scale :	100%

Model No.: C3990TLD	Case Material: Titanium	Movement: VX82	Marketing: Paul
Brand Name: Carly Rex DENMARK	Design Ref. No.: CS2212074	Designer: Tank ★	Date: 22/Dec/2022



Case :	31.0(W)x31.0(H)mm
Dial Opening :	Ø18.5mm
Bracelet / Strap :	12.0x10.0mm
Crown :	Ø3.5mm
Water Resistant :	3ATM
Scale :	100%

Model No.:	Case Material: Alloy	Movement: 2035	Marketing: Paul
Brand Name: Carly Rex DENMARK	Design Ref. No.: CS2212065	Designer: Tank ★	Date: 15/Dec/2022



Case :	32.0(W)x37.0(H)mm
Dial Opening :	Ø24.0mm
Bracelet / Strap :	14.0x12.0mm
Crown :	Ø3.5mm
Water Resistant :	3ATM
Scale :	100%

Model No.:	Case Material: Stainless steel	Movement: 2035	Marketing: Ho
Brand Name: Carly Rex DENMARK	Design Ref. No.: CS2212004	Designer: Andrew ★	Date: 06/Dec/2022



Version A



Version B



Version C

Logo size: 8.5mm

Case :	36.0(W)x45.5(H)mm
Dial Opening :	32.0(W)x32.0(H)mm
Bracelet / Strap :	19.0x19.0mm
Crown :	Ø4.5mm
Water Resistant :	3ATM
Scale :	100%

Model No.:	Case Material: Alloy	Movement: 2035	Marketing: Peggy
Brand Name: Carly Rex DENMARK	Design Ref. No.: CS2210057	Designer: Andrew ★	Date: 18/Oct/2022



Case :	32.0(W)x38.0(H)mm
Dial Opening :	Ø25.5mm
Bracelet / Strap :	20.0x16.0mm
Crown :	Ø4.0mm
Water Resistant :	3ATM
Scale :	100%

Model No.:	Case Material: Stainless steel	Movement: 2035	Marketing: Paul
Brand Name: Carly Rex DENMARK	Design Ref. No.: CS2210001	Designer: Andrew ★	Date: 06/Oct/2022



Version A



Version B



Version C

Case :	28.7(W)x32.2(H)mm
Dial Opening :	Ø20.0mm
Bracelet / Strap :	12.0mm
Crown :	Ø3.5mm
Water Resistant :	3ATM
Scale :	100%

Model No.:	Case Material: Alloy	Movement: 2035	Marketing: Niki
Brand Name: Carly Rex DENMARK	Design Ref. No.: CS2210006	Designer: Andrew ★	Date: 06/Oct/2022



Case :	23.0(W)x30.0(H)mm
Dial Opening :	15.5x19.5mm
Bracelet / Strap :	14.0x12.0mm
Crown :	Ø3.5mm
Water Resistant :	3ATM
Scale :	100%

Model No.:	Case Material: Alloy	Movement: PC20	Marketing: Kristy
Brand Name: Carly Rex DENMARK	Design Ref. No.: CS2209002	Designer: Tank ★	Date: 01/Sep/2022



C2832SLX-A



C2832SLX-B



C2832SLX-C

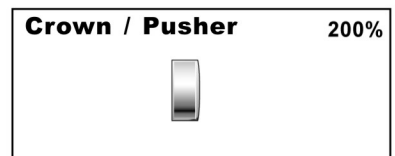
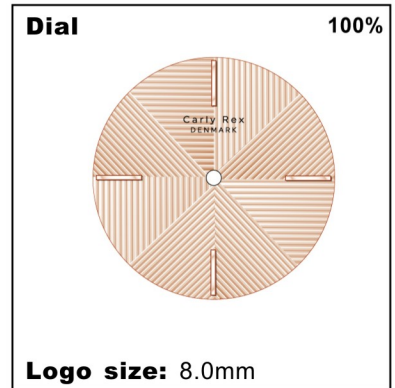
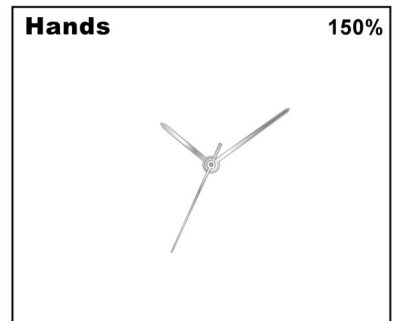

Case :	36.0(W)x42.0(H)mm
Dial Opening :	Ø32.0mm
Bracelet / Strap :	14.0mm #F659
Crown :	Ø4.0mm
Water Resistant :	3ATM
Scale :	100%

Model No.: C2832SLX	Case Material: Stainless steel	Movement: PC21J	Marketing: Ho
Brand Name: Carly Rex DENMARK	Design Ref. No.: CS2208006	Designer: Tank ★	Date: 12/Aug/2022



C4056SLX-A



C4056SLX-B



C4056SLX-C

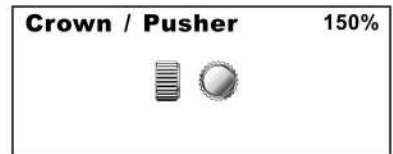

Case :	Existing Case 23.5(W)x35.5(H)mm
Dial Opening :	18.0(W)x22.5(H)mm
Bracelet / Strap :	16.0x16.0mm
Crown :	Ø3.5mm
Water Resistant :	3ATM
Scale :	100%

Model No.: C4056SLX	Case Material: Stainless steel	Movement: VJ20	Marketing: Peggy
Brand Name: Carly Rex DENMARK	Design Ref. No.: CS2207045A	Designer: Tank/Andrew	Date: 13/July/2022



Version A



Version B



Version C

Logo size: 7.0mm



Case :	36.0(W)x44.0(H)mm
Dial Opening :	Ø31.0mm
Bracelet / Strap :	18.0x16.0mm
Crown :	Ø3.5mm
Water Resistant :	3ATM
Scale :	100%

Model No.:	Case Material: Stainless steel	Movement: VX51	Marketing: Ho
Brand Name: Carly Rex DENMARK	Design Ref. No.: CS2206069	Designer: Tank ★	Date: 28/Jun/2022



Version A



Version B



Version C

Logo size: 4.5mm

Case :	21.0(W)x32.0(H)mm
Dial Opening :	14.5x20.5mm
Bracelet / Strap :	16.0x14.0mm
Crown :	Ø3.0mm
Water Resistant :	3ATM
Scale :	100%

Model No.:	Case Material: Stainless steel	Movement: VX50	Marketing: Ho
Brand Name: Carly Rex DENMARK	Design Ref. No.: CS2206072	Designer: Tank ★	Date: 29/Jun/2022



Version A



Version B



Version C

Logo size: 7.5mm

Case :	32.0(W)x40.0(H)mm
Dial Opening :	Ø25.0mm
Bracelet / Strap :	
Crown :	Ø5.0mm
Water Resistant :	3ATM
Scale :	100%

Model No.:	Case Material: Alloy	Movement: 2035	Marketing: Peggy
Brand Name: Carly Rex DENMARK	Design Ref. No.: CS2206031	Designer: Andrew ★	Date: 16/Jun/2022



Version A



Version B



Version C



Version D

Case :	25.0(W)x30.0(H)mm
Dial Opening :	
Bracelet / Strap :	
Crown :	
Water Resistant :	3ATM
Scale :	100%

Model No.:	Case Material: Alloy	Movement: DIGITAL	Marketing: Peggy
Brand Name: Carly Rex DENMARK	Design Ref. No.: CS2205002	Designer: Tank ★	Date: 05/May/2022



Version A



Version B



Version C



Version D

Case :	34.0(W)x37.0(H)mm
Dial Opening :	
Bracelet / Strap :	
Crown :	
Water Resistant :	3ATM
Scale :	100%

Model No.:	Case Material: Alloy	Movement: DIGITAL	Marketing: Peggy
Brand Name: Carly Rex DENMARK	Design Ref. No.: CS2205004	Designer: Tank ★	Date: 05/May/2022



Version A



Logo size: 8.5mm

Version B



Version C



Version D

Case :	32.0(W)x39.0(H)mm
Dial Opening :	
Bracelet / Strap :	
Crown :	
Water Resistant :	3ATM
Scale :	100%

Model No.:	Case Material: Alloy	Movement: DIGITAL	Marketing: Peggy
Brand Name: Carly Rex DENMARK	Design Ref. No.: CS2205003D	Designer: Tank ★	Date: 12/May/2022



Version A

Version B

Version C

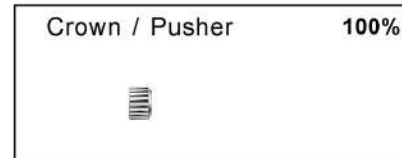
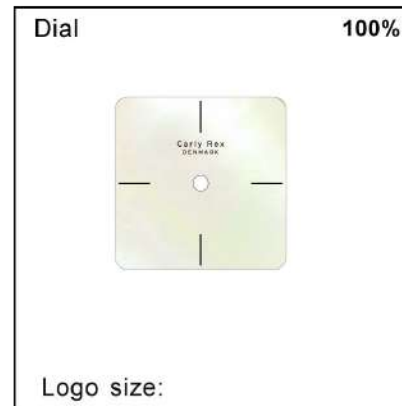
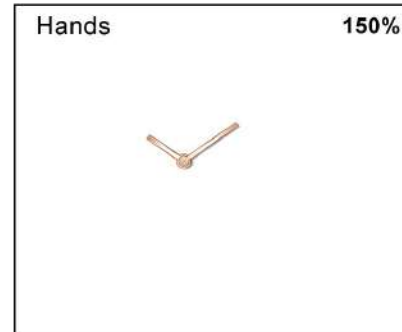

Case :	26.0(W)x26.0(H)mm
Dial Opening :	Ø23.2mm
Bracelet / Strap :	16.0-14mm
Crown :	Ø3.5mm
Water Resistant :	3ATM
Scale :	100%

Model No.:	PJ No.:	Movement: 2025	Marketing:
Brand Name:	Design Ref. No.: LA210360c	Designer:	Date: 23/FEB/2022



A

B

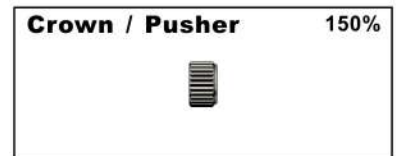
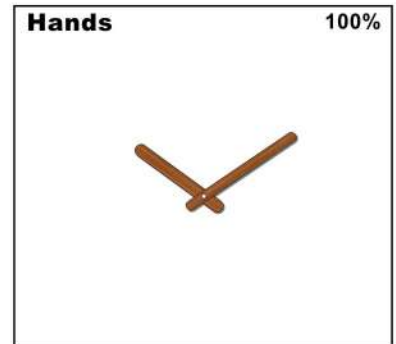

Case :	39.5(W)x39.5(H)mm
Dial Opening :	Ø34.0mm
Bracelet / Strap :	18.0x18.0mm
Crown :	Ø4.0mm
Water Resistant :	3ATM
Scale :	100%

Model No.:	Case Material: Stainless steel	Movement: 2025	Marketing: Ho
Brand Name: Carly Rex DENMARK	Design Ref. No.: CS2112059A	Designer: Tank	Date: 12/Jan/2022



C



D

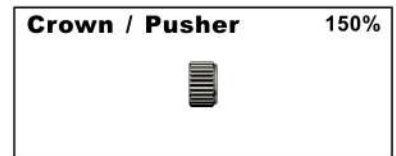
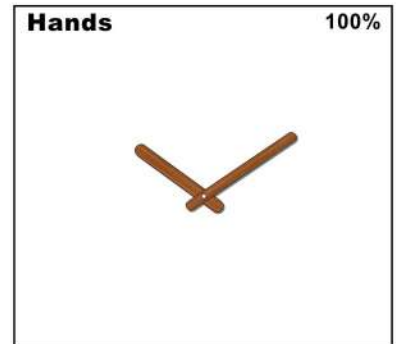

Case :	39.5(W)x39.5(H)mm
Dial Opening :	Ø34.0mm
Bracelet / Strap :	18.0x18.0mm
Crown :	Ø4.0mm
Water Resistant :	3ATM
Scale :	100%

Model No.:	Case Material: Stainless steel	Movement: 2025	Marketing: Ho
Brand Name: Carly Rex DENMARK	Design Ref. No.: CS2112059A	Designer: Tank	Date: 12/Jan/2022



Version A

Version B

Version C

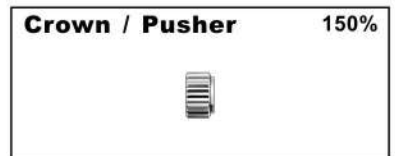
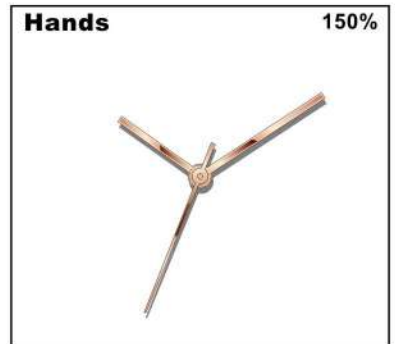

Case :	36.5(W)x43.0(H)mm
Dial Opening :	Ø30.0mm
Bracelet / Strap :	17.0x14.0mm
Crown :	Ø4.0mm
Water Resistant :	3ATM
Scale :	100%

Model No.:	Case Material: Stainless steel	Movement: 2035	Marketing: Andy
Brand Name: Carly Rex DENMARK	Design Ref. No.: CS2111060B	Designer: Andrew	Date: 23/Nov/2021



C3559ALX-A

C3559ALX-B

C3559ALX-C

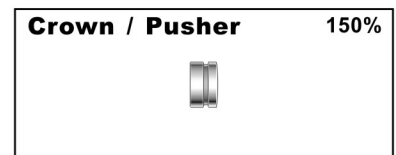
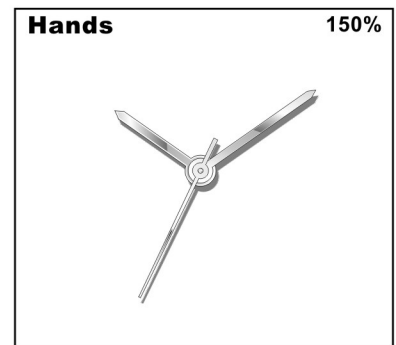

Case :	Existing Case 34.0(W)x34.0(H)mm
Dial Opening :	Ø31.0mm
Bracelet / Strap :	16.0x14.0mm
Crown :	Ø4.0mm
Water Resistant :	3ATM
Scale :	100%

Model No.: C3559ALX	Case Material: Alloy	Movement: PC21S	Marketing: Paul
Brand Name: Carly Rex DENMARK	Design Ref. No.: CS2108011D	Designer: Tank/Andrew	Date: 18/Aug/2021