



Version-A



Version-B



Version-C

| | |
|---------------------------|-------------------|
| Case : | 34.0(W)x42.0(H)mm |
| Dial Opening : | Ø26.5mm |
| Bracelet / Strap : | 14.0x12.0mm |
| Crown : | Ø4.5mm |
| Water Resistant : | 3ATM |
| Scale : | 100% |

| | | | |
|-------------------------------|-------------------------------------|---------------------------------|----------------------------|
| Model No.: BD-2196S | Case Material: S.S | Movement: Miyota 6P29 | Marketing: |
| Brand Name: | Design Ref. No.: BD-22001 | Designer: | Date: 01/03/2022 |



Version A

Version B

Version C

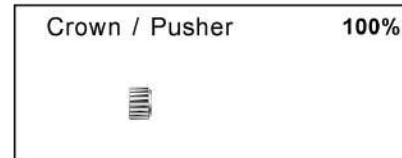
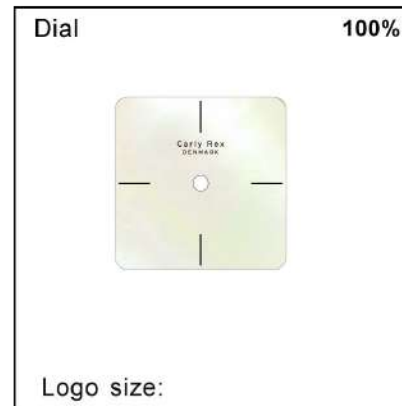
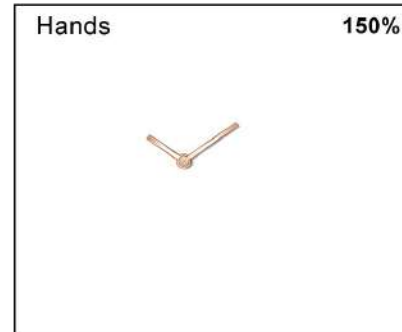

| | |
|--------------------|-------------------|
| Case : | 26.0(W)x26.0(H)mm |
| Dial Opening : | Ø23.2mm |
| Bracelet / Strap : | 16.0-14mm |
| Crown : | Ø3.5mm |
| Water Resistant : | 3ATM |
| Scale : | 100% |

| | | | |
|-------------|-------------------------------|-------------------|----------------------|
| Model No.: | PJ No.: | Movement: 2025 | Marketing: |
| Brand Name: | Design Ref. No.: LA210360c | Designer: | Date: 23/FEB/2022 |

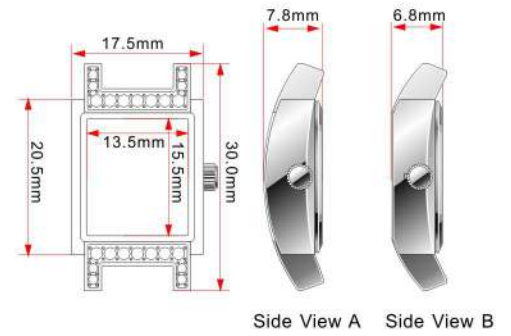

| | |
|---------------------------|-------------------|
| Case : | 17.5(W)x30.0(H)mm |
| Dial Opening : | 13.5(W)x15.5(H)mm |
| Bracelet / Strap : | 14.0x14.0mm |
| Crown : | Ø3.5mm |
| Water Resistant : | 3ATM |
| Scale : | 100% |

| | | | |
|--|--|----------------------------|-----------------------------|
| Model No.: | Case Material: Stainless steel | Movement: 5Y30 | Marketing: Niki |
| Brand Name: Carly Rex DENMARK | Design Ref. No.: CS2112058B | Designer: Andrew | Date: 14/Jan/2022 |



A

B

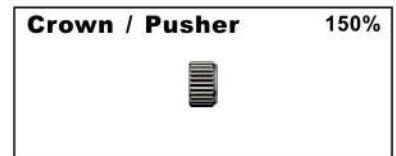
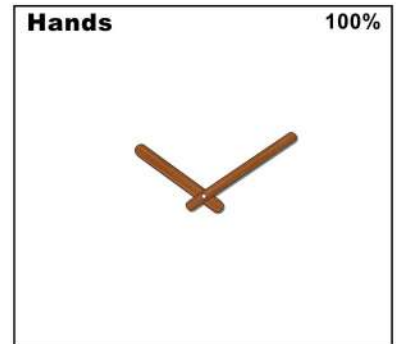

| | |
|---------------------------|-------------------|
| Case : | 39.5(W)x39.5(H)mm |
| Dial Opening : | Ø34.0mm |
| Bracelet / Strap : | 18.0x18.0mm |
| Crown : | Ø4.0mm |
| Water Resistant : | 3ATM |
| Scale : | 100% |

| | | | |
|--|--|--------------------------|-----------------------------|
| Model No.: | Case Material: Stainless steel | Movement: 2025 | Marketing: Ho |
| Brand Name: Carly Rex DENMARK | Design Ref. No.: CS2112059A | Designer: Tank | Date: 12/Jan/2022 |



C



D

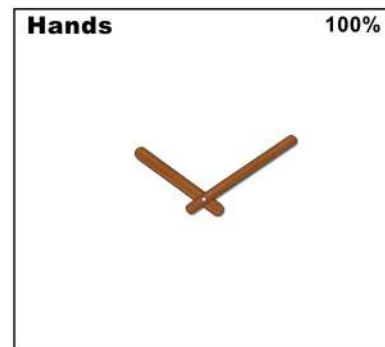

| | |
|---------------------------|-------------------|
| Case : | 39.5(W)x39.5(H)mm |
| Dial Opening : | Ø34.0mm |
| Bracelet / Strap : | 18.0x18.0mm |
| Crown : | Ø4.0mm |
| Water Resistant : | 3ATM |
| Scale : | 100% |

| | | | |
|--|--|--------------------------|-----------------------------|
| Model No.: | Case Material: Stainless steel | Movement: 2025 | Marketing: Ho |
| Brand Name: Carly Rex DENMARK | Design Ref. No.: CS2112059A | Designer: Tank | Date: 12/Jan/2022 |

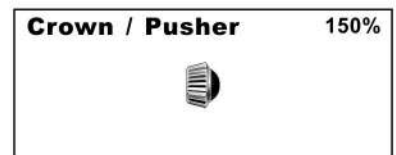

| | |
|---------------------------|-------------------|
| Case : | 22.0(W)x36.5(H)mm |
| Dial Opening : | 17.0(W)x24.0(H)mm |
| Bracelet / Strap : | 12.0x10.0mm |
| Crown : | Ø4.0mm |
| Water Resistant : | 3ATM |
| Scale : | 100% |

| | | | |
|--|---------------------------------------|----------------------------|-----------------------------|
| Model No.: | Case Material: Alloy | Movement: 2035 | Marketing: Paul |
| Brand Name: Carly Rex DENMARK | Design Ref. No.: CS2111018B | Designer: Andrew | Date: 23/Nov/2021 |



| | |
|---------------------------|-------------------|
| Case : | 34.0(W)x38.5(H)mm |
| Dial Opening : | Ø19.0mm |
| Bracelet / Strap : | 12.0x12.0mm |
| Crown : | Ø3.5mm |
| Water Resistant : | 3ATM |
| Scale : | 100% |

| | | | |
|--|---------------------------------------|----------------------------|-----------------------------|
| Model No.: | Case Material: Alloy | Movement: PC20 | Marketing: Ho |
| Brand Name: Carly Rex DENMARK | Design Ref. No.: CS2111044A | Designer: Andrew | Date: 22/Nov/2021 |



Version A

Version B

Version C

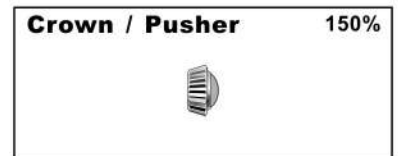
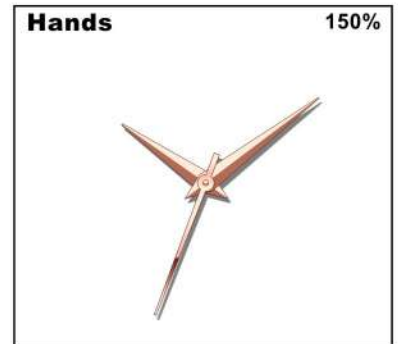

| | |
|---------------------------|-------------------|
| Case : | 33.0(W)x38.0(H)mm |
| Dial Opening : | Ø27.0mm |
| Bracelet / Strap : | 16.0x14.0mm |
| Crown : | Ø4.5mm |
| Water Resistant : | 3ATM |
| Scale : | 100% |

| | | | |
|--|---------------------------------------|--------------------------|-----------------------------|
| Model No.: | Case Material: Alloy | Movement: PC21 | Marketing: Paul |
| Brand Name: Carly Rex DENMARK | Design Ref. No.: CS2111054A | Designer: Tank | Date: 18/Nov/2021 |



| | |
|---------------------------|-------------------|
| Case : | 30.6(W)x35.6(H)mm |
| Dial Opening : | Ø25.0mm |
| Bracelet / Strap : | 14.0x14.0mm |
| Crown : | Ø3.0mm |
| Water Resistant : | 3ATM |
| Scale : | 100% |

| | | | |
|--|--|--------------------------|-----------------------------|
| Model No.: | Case Material: Stainless steel | Movement: 2035 | Marketing: Andy |
| Brand Name: Carly Rex DENMARK | Design Ref. No.: CS2111058A | Designer: Tank | Date: 22/Nov/2021 |



Version A

Version B

Version C

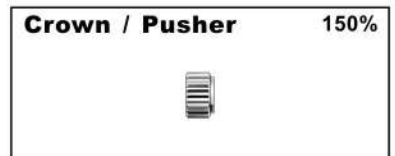
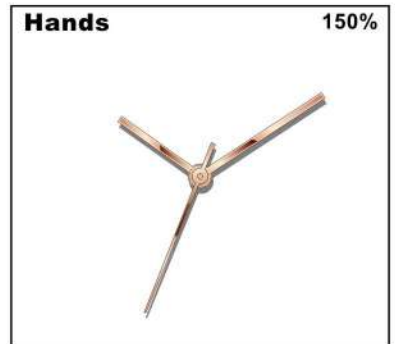

| | |
|---------------------------|-------------------|
| Case : | 36.5(W)x43.0(H)mm |
| Dial Opening : | Ø30.0mm |
| Bracelet / Strap : | 17.0x14.0mm |
| Crown : | Ø4.0mm |
| Water Resistant : | 3ATM |
| Scale : | 100% |

| | | | |
|--|--|----------------------------|-----------------------------|
| Model No.: | Case Material: Stainless steel | Movement: 2035 | Marketing: Andy |
| Brand Name: Carly Rex DENMARK | Design Ref. No.: CS2111060B | Designer: Andrew | Date: 23/Nov/2021 |



A



B



C

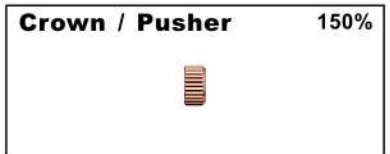
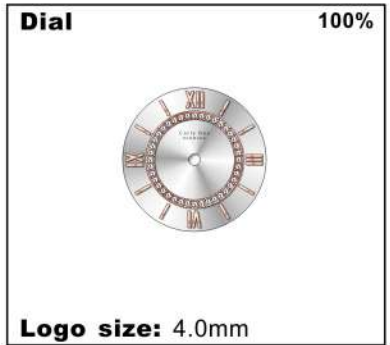

| | |
|---------------------------|-------------------|
| Case : | 24.0(W)x30.0(H)mm |
| Dial Opening : | Ø19.0mm |
| Bracelet / Strap : | 8.0x8.0mm |
| Crown : | Ø3.5mm |
| Water Resistant : | 3ATM |
| Scale : | 100% |

| | | | |
|--|--------------------------------------|--------------------------|-----------------------------|
| Model No.: | Case Material: Alloy | Movement: PC21 | Marketing: Paul |
| Brand Name: Carly Rex DENMARK | Design Ref. No.: CS2111017 | Designer: Tank | Date: 05/Nov/2021 |



Version A

Version B

Version C



| | |
|---------------------------|-------------------|
| Case : | 22.0(W)x36.5(H)mm |
| Dial Opening : | 17.0(W)x24.0(H)mm |
| Bracelet / Strap : | 12.0x10.0mm |
| Crown : | Ø4.0mm |
| Water Resistant : | 3ATM |
| Scale : | 100% |

| | | | |
|--|---------------------------------------|----------------------------|-----------------------------|
| Model No.: | Case Material: Alloy | Movement: 2035 | Marketing: Paul |
| Brand Name: Carly Rex DENMARK | Design Ref. No.: CS2111018A | Designer: Andrew | Date: 09/Nov/2021 |



Version A

Version B

Version C

| | |
|---------------------------|-------------------|
| Case : | 23.5(W)x35.5(H)mm |
| Dial Opening : | 18.0x22.5mm |
| Bracelet / Strap : | 16.0x16.0mm |
| Crown : | Ø3.5mm |
| Water Resistant : | 3ATM |
| Scale : | 100% |

| | | | |
|--|--|--------------------------|----------------------------|
| Model No.: 2303S | Case Material: Stainless steel | Movement: VJ21 | Marketing: |
| Brand Name: Carly Rex DENMARK | Design Ref. No.: BD-21022 | Designer: | Date: 27/10/2021 |



Version D

Version E

Version F

| | |
|---------------------------|-------------------|
| Case : | 23.5(W)x35.5(H)mm |
| Dial Opening : | 18.0x22.5mm |
| Bracelet / Strap : | 16.0x14.0mm |
| Crown : | Ø3.5mm |
| Water Resistant : | 3ATM |
| Scale : | 100% |

| | | | |
|--|--|--------------------------|----------------------------|
| Model No.: 2303S | Case Material: Stainless steel | Movement: VJ21 | Marketing: |
| Brand Name: Carly Rex DENMARK | Design Ref. No.: BD-21022 | Designer: | Date: 29/10/2021 |



C3559ALX-A

C3559ALX-B

C3559ALX-C

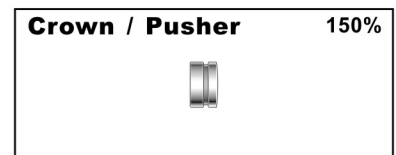
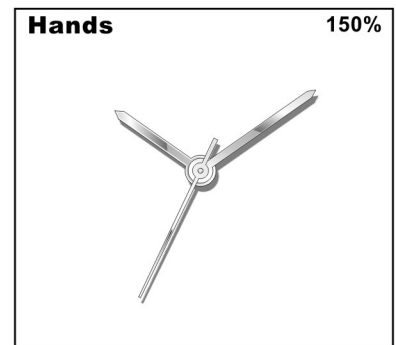

| | |
|---------------------------|------------------------------------|
| Case : | Existing Case 34.0(W)x34.0(H)mm |
| Dial Opening : | Ø31.0mm |
| Bracelet / Strap : | 16.0x14.0mm |
| Crown : | Ø4.0mm |
| Water Resistant : | 3ATM |
| Scale : | 100% |

| | | | |
|--|---------------------------------------|---------------------------------|-----------------------------|
| Model No.: C3559ALX | Case Material: Alloy | Movement: PC21S | Marketing: Paul |
| Brand Name: Carly Rex DENMARK | Design Ref. No.: CS2108011D | Designer: Tank/Andrew | Date: 18/Aug/2021 |



| | |
|---------------------------|-------------------|
| Case : | 36.0(W)x42.0(H)mm |
| Dial Opening : | Ø30.0mm |
| Bracelet / Strap : | 14.0x14.0mm |
| Crown : | Ø3.5mm |
| Water Resistant : | 3ATM |
| Scale : | 100% |

| | | | |
|--|--------------------------------------|----------------------------|-----------------------------|
| Model No.: | Case Material: Alloy | Movement: PC21 | Marketing: Peggy |
| Brand Name: Carly Rex DENMARK | Design Ref. No.: CS2109066 | Designer: Tank ★ | Date: 16/Sep/2021 |

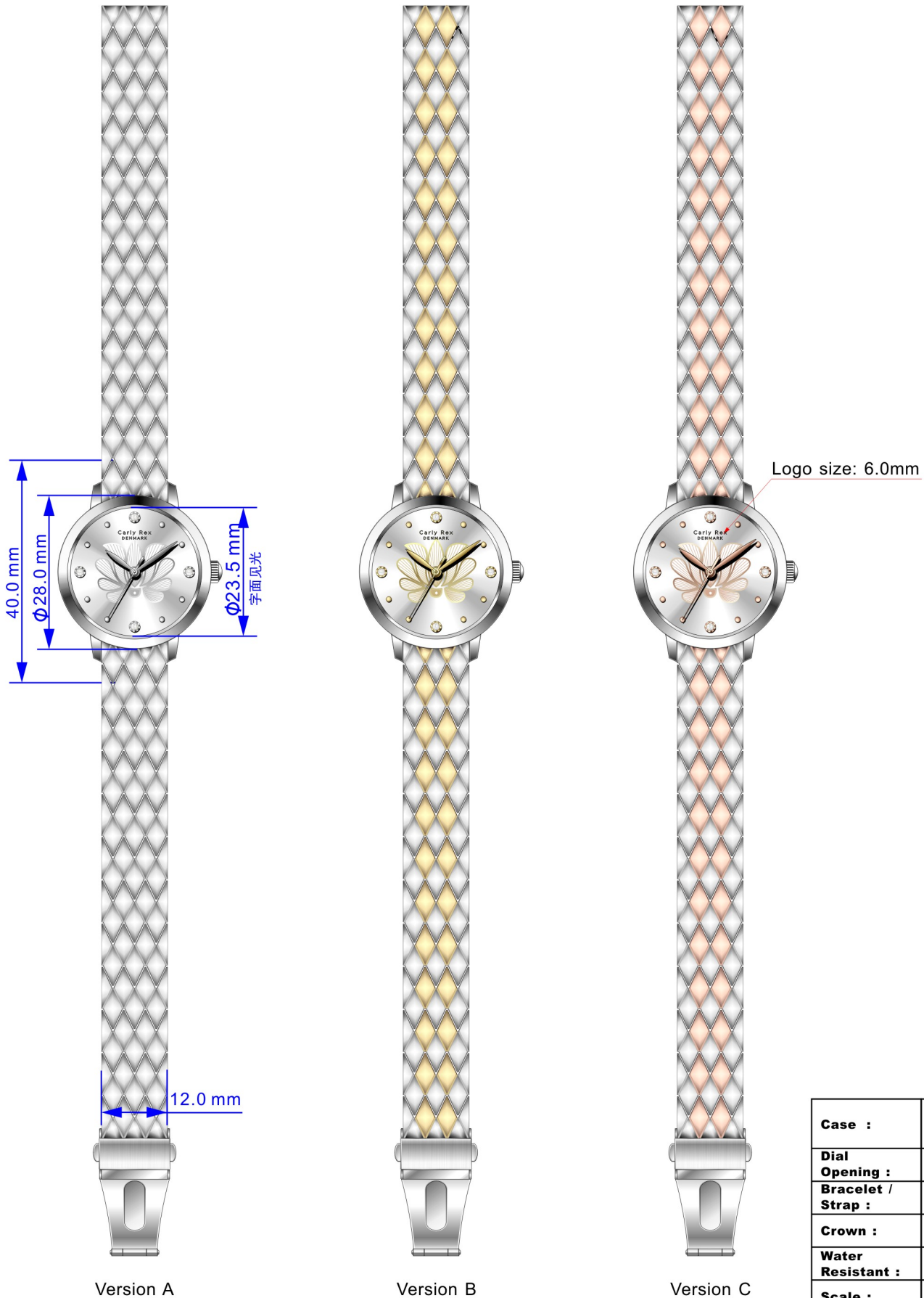

| | |
|---------------------------|-------------------|
| Case : | 28.0(W)x33.0(H)mm |
| Dial Opening : | Φ 23.5mm |
| Bracelet / Strap : | 12.0x12.0mm |
| Crown : | Φ 4.0mm |
| Water Resistant : | 3ATM |
| Scale : | 100% |

| | | | |
|--|--------------------------------------|----------------------------|-----------------------------|
| Model No.: | Case Material: Alloy | Movement: PC21 | Marketing: Peggy |
| Brand Name: Carly Rex DENMARK | Design Ref. No.: CS2109067 | Designer: Tank ★ | Date: 16/Sep/2021 |

STONE: 16 PCS



| | |
|---------------------------|-------------------|
| Case : | 26.5(W)x32.0(H)mm |
| Dial Opening : | Ø22.0mm |
| Bracelet / Strap : | 11.5x10.5mm |
| Crown : | Ø3.5mm |
| Water Resistant : | 3ATM |
| Scale : | 100% |

| | | | |
|--|--------------------------------------|----------------------------|-----------------------------|
| Model No.: | Case Material: Alloy | Movement: PC21 | Marketing: Peggy |
| Brand Name: Carly Rex DENMARK | Design Ref. No.: CS2109068 | Designer: Tank ★ | Date: 16/Sep/2021 |



Silver white

Sunray

White

Movable

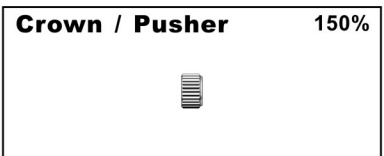

| | |
|---------------------------|-------------|
| Case : | Ø28.0mm |
| Dial Opening : | Ø23.5mm |
| Bracelet / Strap : | 32.0x32.0mm |
| Crown : | Ø3.0mm |
| Water Resistant : | 3ATM |
| Scale : | 100% |

Version A

Version B

Version C

| | | | |
|--|---------------------------------------|--------------------------|-----------------------------|
| Model No.: | Case Material: Alloy | Movement: 2035 | Marketing: Kristy |
| Brand Name: Carly Rex DENMARK | Design Ref. No.: CS2107023B | Designer: Tank | Date: 04/Aug/2021 |



C3015SLX-A

C3015SLX-B

C3015SLX-C

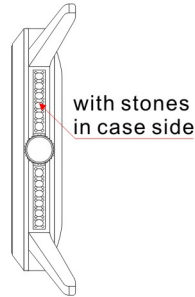

Side View

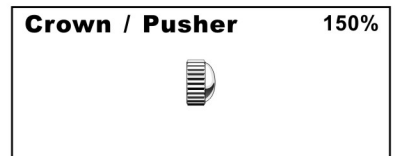
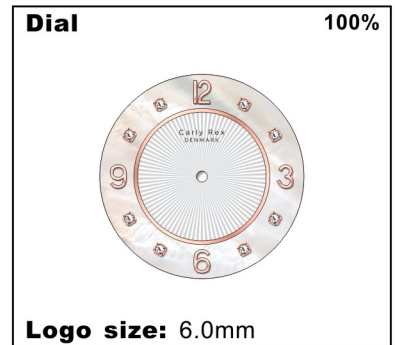

| | |
|---------------------------|-------------------|
| Case : | 32.0(W)x38.5(H)mm |
| Dial Opening : | Ø27.0mm |
| Bracelet / Strap : | 18.0x14.0mm |
| Crown : | Ø4.0mm |
| Water Resistant : | |
| Scale : | 100% |

| | | | |
|--|--|--------------------------|-----------------------------|
| Model No.: C3015SLX | Case Material: Stainless steel | Movement: Y121 | Marketing: Niki |
| Brand Name: Carly Rex DENMARK | Design Ref. No.: CS2107030A | Designer: Tank | Date: 02/Aug/2021 |